



New Rev

APPROVAL SHEET

CUSTOMER : _____

DEVICE NAME : **PHOTO DIODE**

MODEL NO. : **SPD-5CB6-I1**

ISSUED DATE : **OCT.22. 2012**

	ISSUE	REVIEW	REVIEW	APPR'D
ISSUED DEPT.			蒋宏华	



TEL : +86-755-88878308
FAX : +86-755-88828216
Email : sek@seksemi.com
<http://www.seksemi.com>

● Features:

1. Wide receiving angle
2. Linear response vs. irradiance
3. Fast switching time
4. End-looking Package ideal for space limited applications
5. Lens Appearance: Black
6. This product doesn't contain restriction substance, comply RoHS standard

● Applications:

The SPD-5CB6-I1 device consists of a PIN silicon photodiode molded in a black epoxy package which allows spectral response infrared light wavelengths. The wide receiving angle provides relatively even reception over a large area. The end-looking package is designed for easy PC board mounting. This photodiode is mechanically and spectrally matched to BRIGHT's GaAs and GaAlAs series of infrared emitting diodes.

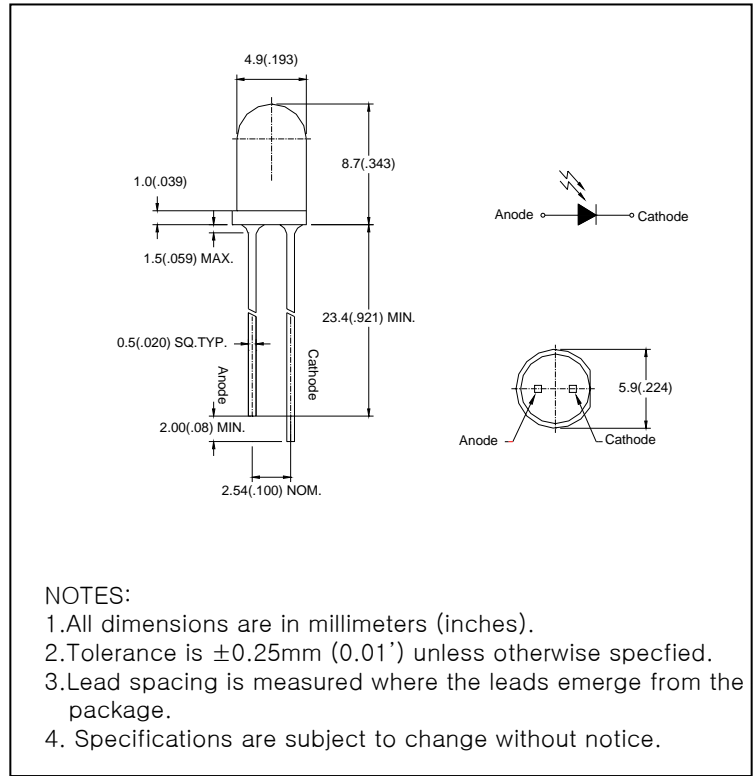
● Package dimensions:

● Absolute Maximum Ratings(Ta=25°C)

Parameter	Maximum Rating	Unit
Power Dissipation	100	mW
Reverse Breakdown Voltage	60V	
Operating Temperature	-45°C ~ +85°C	
Storage Temperature Range	-45°C ~ +100°C	
Lead Soldering Temperature	260°C for 5 seconds	

*1Condition for IFP is pulse of 1/10 duty and 0.1msec width.

● Electrical and optical characteristics(Ta=25°C)

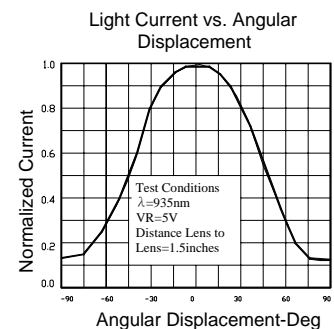
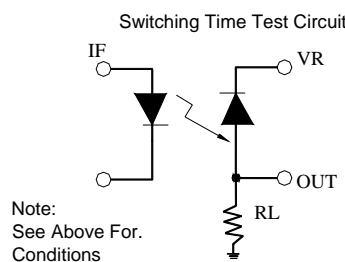
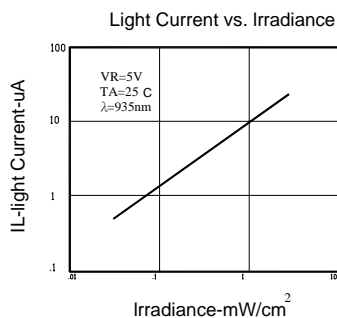
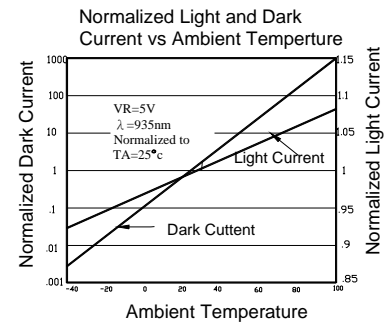
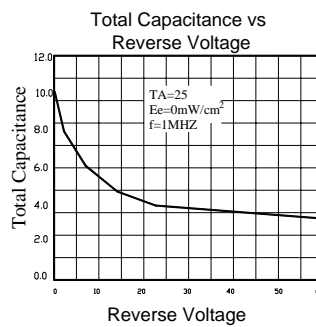
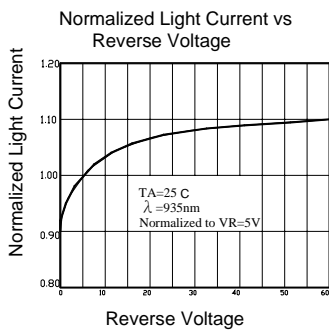
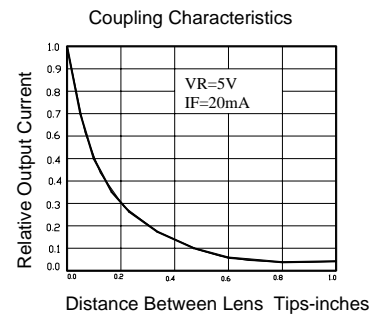
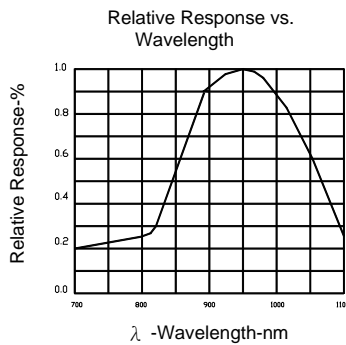
PARAMETER	SYMBOL	MIN	TYP	MAX	UNITS	TEST CONDITIONS
Reverse Light Current	I_L	-	50		μA	$V_R=5V, E_e=1mW/cm^2$
Reverse Dark Current	I_D	-	-	30	nA	$V_R=10V, E_e=0 mW/cm^2$
Reverse Break down Voltage	$V_{(BR)}$	30	-	-	-	$I_R=100 \mu A$
Forward Voltage	V_F	-	-	1.2	V	$I_F=1mA$
Total Capacitance	C_T	-	9	-	PF	$V_R=5V, E_e=0, f=1.0MHZ$
Rise Time/ Fall Time	tr/tf	-	50	-	ns	$V_R=20V, \lambda =940nm, RL=50 \Omega$

● Typical electro-optical characteristics curves

Disclaimer

All products, product specifications and data are subject to change without notice to improve reliability, function or design or otherwise.

SEKwang Semiconductor Co.,Ltd., its affiliates, agents, and employees, and all persons acting on its or their behalf(collectively, SEKwang), Disclaim any and all liability for any errors, inaccuracies or incompleteness contained in any datasheet or in any other disclosure relating to any products.

SEKwang makes no warranty, representation or guarantee regarding the suitability of the products for any particular purpose or the continuing production of any products. To the maximum extent permitted by applicable law, SEKwang disclaims

(1) any and all liability arising out of the application or use of any products, (ii)any and all liability, including without limitation special, consequential or incidental damages, and any and all implied warranties, (iii)including warranties of fitness for particular purpose, non-infringement and merchantability.

Statements regarding the suitability of products for certain types of applications are based on SEKwang's knowledge of typical requirements that are often placed on SEKwang products in generic applications. Such statements are not binding statements about the suitability of products for a particular application. It is the customers' responsibility to validate that a particular products with the properties described in the products specification is suitable for use in a particular application. Parameters provided in datasheets and /or specifications may vary in different applications and performance may vary over time. All operating parameters, including typical parameters, must be validated for each customer application by the customers's technical experts. Products specifications do not expand or otherwise modify SEKwang's terms and conditions of purchase, including but not limited to the warranty expressed therein

Except as expressly indicated in writing, Sekwang products are not designed for use in medical, life-saving,or life-sustaining applications or for any other application in which the failure of the SEKwang products could result in personal injury or death. Customers using or selling SEKwang products not expressly indicated for use in such applications do so at their own risk and agree to fully indemnify and hold SEKwang and its distributors harmless from and against any and all claims, liabilities, expenses and damages arising or resulting in connection with such use or sale, including attorneys fees, even if such claim alleges that SEKwang or its distributor was negligent regarding the design or manufacture of the part. Please contact authorized SEKwang personnel to obtain written terms and conditions regarding products designed for such applications.

No license, express or implied, by estoppel or otherwise, to any intellectual property rights is granted by this documents or by any conduct of SEKwang. Products names and markings noted herein maybe trademarks of their respective owners.